

PF/SF BINS

ICE STORAGE BIN SERIES

Item # _____

Project: _____

Qty: _____

*AutoCad available on KCL

PF/SF BINS

6/11

Item # 13163

BIN DIMENSIONS

W x D x H

B-250PF

30 x 32^{1/2} x 33^{3/8}*

B-300PF/SF

22 x 32^{1/2} x 46*

BD-300PF/SF

22 x 32^{1/2} x 46*

B-500PF/SF

30 x 32^{1/2} x 46*

BD-500PF/SF

30 x 32^{1/2} x 46*

B-700PF/SF

44 x 32^{1/2} x 46*

B-800PF/SF

48 x 32^{1/2} x 46*

B-900PF/SF

52 x 32^{1/2} x 46*

*with 6" adj. legs



B-250PF

B-300PF
B-300SF

B-500PF
B-500SF

B-700PF
B-700SF

B-800PF
B-800SF

B-900PF
B-900SF

BD-300PF BD-500PF
BD-300SF BD-500SF

PF - PVC Coated Galvanized Steel Finish

SF - Stainless Steel Finish

PF BINS

- Ice storage capacity from 250 lbs. up to 900 lbs.
- Vinyl clad galvanized steel cabinet exterior design for easy cleaning

SF BINS

- Ice storage capacity from 300 lbs. up to 900 lbs.
- Stainless steel exterior design for easy cleaning

PF/SF BINS

- Protected by *H-GUARD Plus* Antimicrobial Agent 
- Long lasting attractive appearance
- Polyethylene bin liner for sanitary storage
- Sturdy construction for side by side or stacked ice machine installation
- Foamed-in-place polyurethane insulation, in all bin walls and bottom, provides dependable ice storage

BD Bins

- Fit 24" - 24 1/2" deep ice machine without Top Kit extension

Warranty

Valid in United States, Canada, Puerto Rico, & U.S. Territories. Contact factory for warranty in other countries.

Two Year - Parts & Labor.



ISO 9001:2015



Hoshizaki

PF/SF BINS ICE STORAGE BIN SERIES

- B-250PF**
- B-300PF/SF** **BD-300PF/SF**
- B-500PF/SF** **BD-500PF/SF**
- B-700PF/SF**
- B-800PF/SF**
- B-900PF/SF**

- Up to 230 lbs. of ice storage
- Up to 260 lbs. of ice storage
- Up to 360 lbs. of ice storage
- Up to 550 lbs. of ice storage
- Up to 600 lbs. of ice storage
- Up to 660 lbs. of ice storage

ICE STORAGE BIN APPLICATION

Model Number	Application Capacity Storage	ARI-Rated Storage Capacity	Dimensions W x D x H	Shipping Weight
B-250PF	250 lbs.	230 lbs.	30" x 32 ¹ / ₂ " x 33 ³ / ₈ "	130 lbs.
B(D)-300PF/SF	300 lbs.	260 lbs.	22" x 32 ¹ / ₂ " x 46"	135 lbs.
B(D)-500PF/SF	500 lbs.	360 lbs.	30" x 32 ¹ / ₂ " x 46"	155 lbs.
B-700PF/SF	700 lbs.	550 lbs.	44" x 32 ¹ / ₂ " x 46"	200 lbs.
B-800PF/SF	800 lbs.	600 lbs.	48" x 32 ¹ / ₂ " x 46"	210 lbs.
B-900PF/SF	900 lbs.	660 lbs.	52" x 32 ¹ / ₂ " x 46"	220 lbs.

*height includes 6" adj. legs

ICE MACHINE MODEL APPLICATION

Bin	22" Width KM-320M KM-515M KM-600M KM-650M F-450M F-801M F-1001M KMD-410M KMS-822M FD-1001M	30" Width KM-901M KM-1340M KM-1601M KML Series F-1500M F-2000M KMD-450M KMD-850M KMD-901MRH KMD-901MWH KMS-750/1401* KMS-2000*	44" Width 2 KM-320M 2 KM-515M 2 KM-600M 2 KM-650M 2 F-450M 2 F-801M 2 F-1001M	48" Width KM-1301S KM-1400S KM-1601S KM-1900S KM-2100S KM-2500S
22" Width B-300PF/SF	No Top Kit Needed NEED HS-2153			
BD-300PF/SF	No Top Kit Needed			
30" Width B-250PF B-500PF/SF BD-500PF/SF	Need HS-2033	No Top Kit Needed NEED HS-2129		
44" Width B-700PF/SF	Need HS-2035	Need HS-2034 NEED HS-2130 & HS-2034	No Top Kit Needed	
48" Width B-800PF/SF	Need HS-2035 & HS-2032	Need HS-2034/2032 NEED HS-2131 & HS-2034/2032	Need HS-2032	No Top Kit Needed
52" Width B-900PF/SF	Need HS-2035 & HS-2033	Need HS-2035 NEED HS-2132 & HS-2035	Need HS-2033	Need HS-2032

* KMS Series on bin application additionally requires HS-0224 (Mechanical Bin Control Extension)
 Top Kit Extensions - HS-2153 - for use with B-300 bins
 HS-2129 - for use with B-500 bins
 HS-2130 - for use with B-700 bins
 HS-2131 - for use with B-800 bins
 HS-2132 - for use with B-900 bins

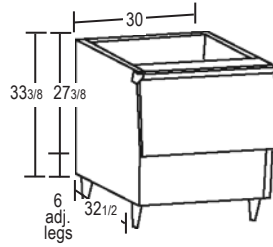

B-250PF

22 x 32¹/₂ x 33³/₈
W x D x H

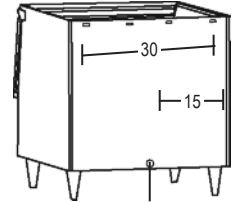

3/4" FPT Drain

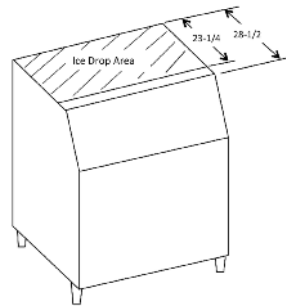
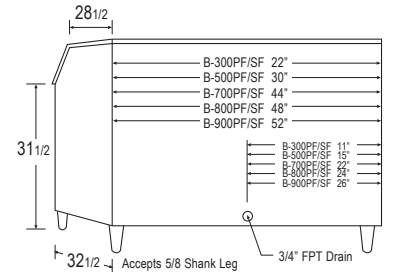
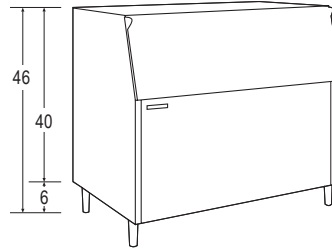

B BINS
Top View

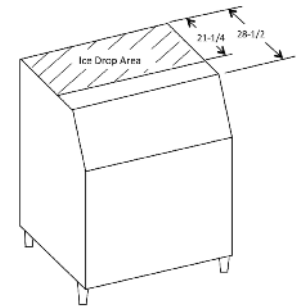

BD BINS
Top View



B-300PF/SF
BD-300PF/SF

22 x 32¹/₂ x 46
W x D x H

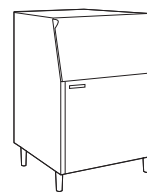

B-500PF/SF
BD-500PF/SF

30 x 32¹/₂ x 46
W x D x H

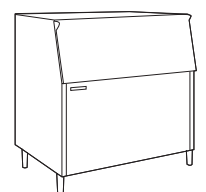

B-700PF/SF

44 x 32¹/₂ x 46
W x D x H

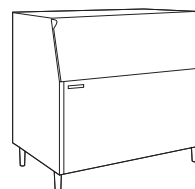

B-800PF/SF

48 x 32¹/₂ x 46
W x D x H

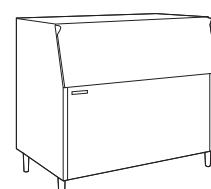

B-900PF/SF

52 x 32¹/₂ x 46
W x D x H

